

GULLIVER

Automations for industrial sliding gates



NET230N 230V a.c. operators with control board, limit switches and encoder

COD.	Art.	EN	Icon	Icon	Icon	Icon	OTHER CHARACTERISTICS
613300	18NET		1800 kg	• • •	NET230N	•	<ul style="list-style-type: none"> - Self locking with limit switches - Speed adjustment and slow down in opening and closing - Motor control by encoder and obstacle detection
613301	18NET/M		1800 kg	• • •	NET230N	•	<ul style="list-style-type: none"> - Self locking - Magnetic limit switches - Speed adjustment and slow down in opening and closing - Motor control by encoder and obstacle detection

All models have: foundation plate (to be cemented) included

400RR 400V a.c. operators with control board, limit switches and encoder

COD.	Art.	EN	Icon	Icon	Icon	Icon	OTHER CHARACTERISTICS
613210	25RRT		2500 kg	• • •	400RR	•	<ul style="list-style-type: none"> - Self locking with limit switches - Anti-crushing safety device - Speed adjustment and slow down in opening and closing - Motor control by encoder and obstacle detection
613215	25RRTF		2500 kg	• • •	400RR	•	<ul style="list-style-type: none"> - Anti-inertia braking device (version 25RRTF only)
613221	25RRT/M		2500 kg	• • •	400RR	•	<ul style="list-style-type: none"> - Self locking - Speed adjustment and slow down in opening and closing - Motor control by encoder and obstacle detection - Magnetic limit switches

All models have: foundation plate (to be cemented) included

212E 230V a.c. operators with control board and limit switches

COD.	Art.	Icon	Icon	Icon	OTHER CHARACTERISTICS
613220*	1503E	1500 kg	• •	212E	<ul style="list-style-type: none"> - Self locking with limit switches - Electronic force adjustment - Automatic working time learning - Controlled input for external safety device

* In order to respect the limit of impact forces foreseen by EN 12453 and EN12445, you must use the external safety devices in compliance with EN 12978.

TECHNICAL INFO	25RRT - 25RRTF - 25RRT/M - 25RRT/IB	18NET - 18NET/M - 18NET/IB - 1503E
Motor power supply (V)	400 AC ± 10 % (50/60 Hz)	230 AC ± 10 % (50/60 Hz)
Maximum power absorption (W)	1200	560
Max thrust (N)	1650	875
Duty cycle (cycles/hours)	17 - with a 14 mt. gate	15 - with a 12 mt. gate
N. max cycles in 24h.	280	240
Built-in capacitor (µF)	/	30
Operating temperature (°C)	-20 ÷ 50	-20 ÷ 50
Motor thermal protection (°C)	/	140
Speed (m/min)	10	10
Weight with packing (Kg)	30	30
Protection degree	IP34 (IP44 with magnetic limit switch)	IP34 (IP44 with magnetic limit switch)

ELECTRICAL DIAGRAM

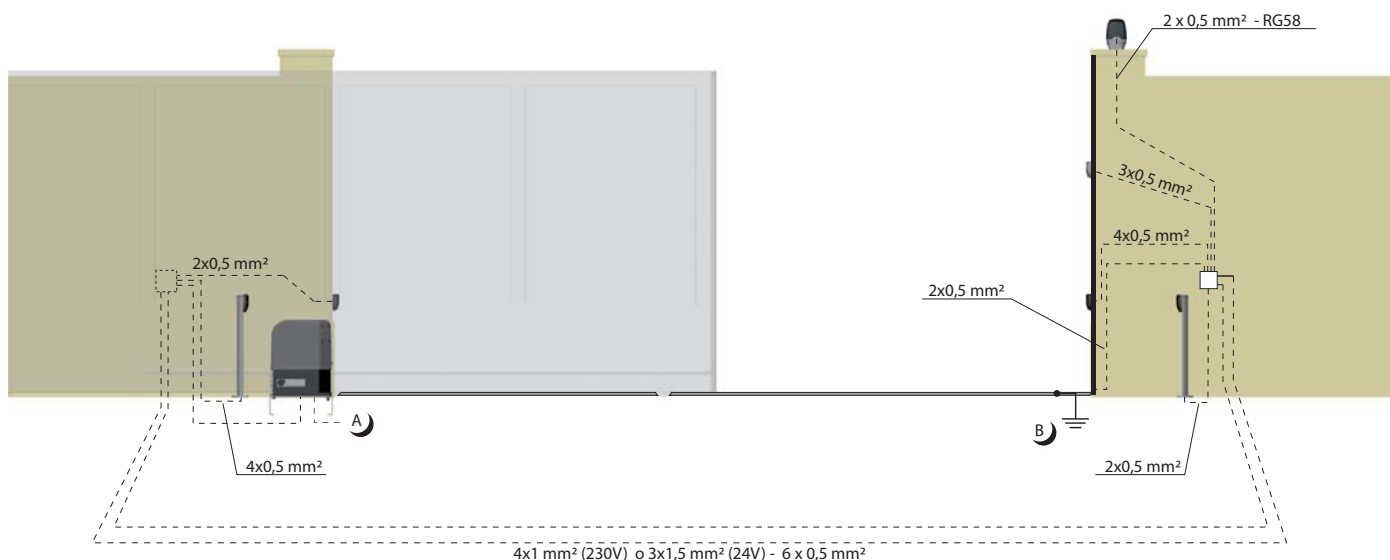

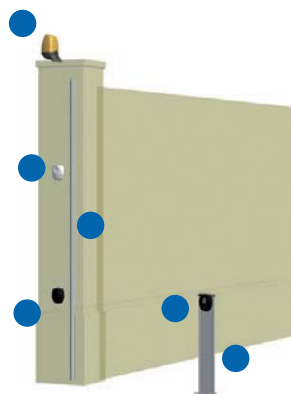
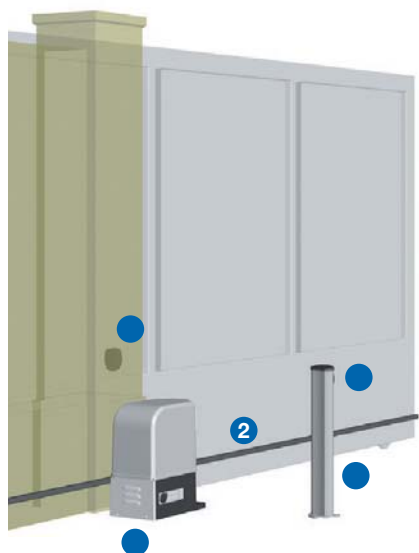

EXAMPLE OF A TYPICAL INSTALLATION

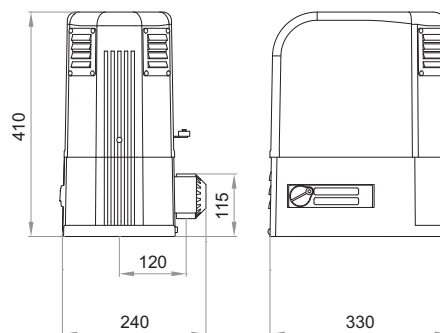

DIMENSIONS

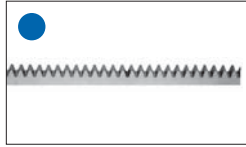

 <p>Cod. 613300 Art. 18NET Operator for industrial sliding gates</p>	 <p>Cod. 126001 Art. 112 Galvanized steel rack 22 x 22 mm (per mt.)</p>	 <p>Cod. 662030 Art. 104LUX Pair of adjustable (15°) surface mounted photocells</p>
 <p>Cod. 664000 Art. PILLY/60 Pair of aluminium columns for photocells, height 55 cm.</p>	 <p>Cod. 171001 Art. 123 Mechanical safety rib, length 200 cm.</p>	 <p>Cod. 663030 Art. 102LUX Keyswitch with two contacts, flush mounted. Supplied with 2 keys.</p>
 <p>Cod. 661062 Art. LED230AI Led flashing light 230V with built-in antenna 433Mhz</p>	 <p>Cod. 672580 Art. TR2 Remote control Black version art. TR2N also available (page 118)</p>	 <p>Cod. 668010 Art. 127 Warning sign</p>

SPECIFIC ACCESSORIES

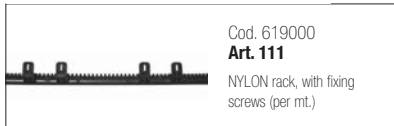

Cod. 619000
Art. 111
NYLON rack, with fixing screws (per mt.)



Cod. 126008
Art. 116
Galvanized steel M6 rack, (per mt.)



Cod. 675580
Art. RADIOBAND RU
868Mhz receiver



Cod. 171000
Art. 124
Mechanical safety rib, 1,5 mt.

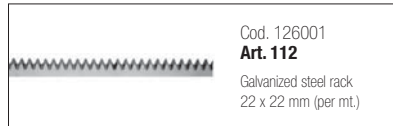

Cod. 126001
Art. 112
Galvanized steel rack 22 x 22 mm (per mt.)



Cod. 360580
Art. M6
M6 Gulliver galvanized gear M=6 Z=12 0e=84



Cod. 171001
Art. 123
Mechanical safety rib, 2 mt.

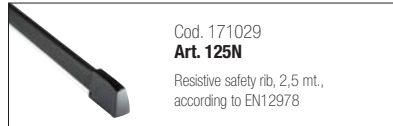

Cod. 171029
Art. 125N
Resistive safety rib, 2,5 mt., according to EN12978



Cod. 126000
Art. 113
Galvanized steel rack 30x12 mm with zinc-plated spacers and fixing screws (per mt.)



Cod. 672900
Art. RADIOBAND TBX
868Mhz transmitter

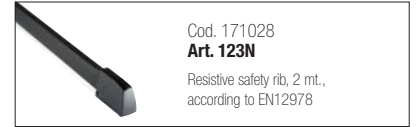

Cod. 171028
Art. 123N
Resistive safety rib, 2 mt., according to EN12978



Cod. 667053
Art. Soft3
Safety rubber profile (complete with aluminium base) useful to reduce the impact forces for sliding and swing gates. 12mt.

OTHER ACCESSORIES



Cod. 677130
Art. 400RR
Digital control board three-phase 400V or single phase 230V for sliding gates

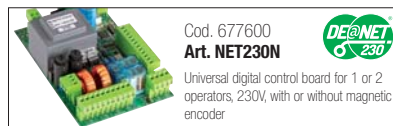

Cod. 677600
Art. NET230N
Universal digital control board for 1 or 2 operators, 230V, with or without magnetic encoder

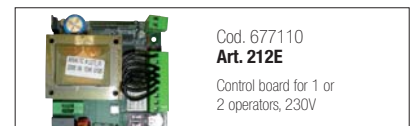

Cod. 677110
Art. 212E
Control board for 1 or 2 operators, 230V



Cod. 661062
Art. LED230AI
Led flashing light 230V with built-in antenna 433Mhz



Cod. 672580
Art. TR2
Remote control
Black version art. TR2N also available (page 118)

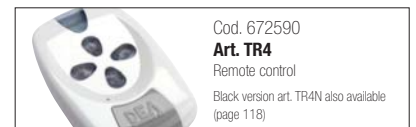

Cod. 672590
Art. TR4
Remote control
Black version art. TR4N also available (page 118)



Cod. 662020
Art. 104MINILUX
Pair of surface mounted photocells, Range 20 mt



Cod. 662030
Art. 104LUX
Pair of adjustable (15°) surface mounted photocells



Cod. 662044
Art. LINEAR
Pair of adjustable photocells (180°) with possibility of synchronized operating. Range 20 Mt



Cod. 662043
Art. LINEAR/B
Pair of adjustable photocells (180°) with tx supplied by a LiOn battery. Range 7/15 Mt



Cod. 681060
Art. COVER
Vandal-proof aluminium cover for art. LINEAR and LINEAR/B



Cod. 663060
Art. KYO
Aluminium vandal-proof keyswitch, flush mounted.



Cod. 663280
Art. DIGIRAD
Wireless keypad



Cod. 663270
Art. DIGINET
Hardwired keypad for BUS connections to MASTER devices of range DE@NET (NET24N, NET230N, MASTERNET)

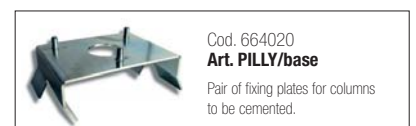

Cod. 664020
Art. PILLY/base
Pair of fixing plates for columns to be cemented.



Cod. 664000
Art. PILLY/60
Pair of aluminium columns for photocells, height 55 cm.



Cod. 664010
Art. PILLY/120
Pair of aluminium columns for photocells, height 100 cm.

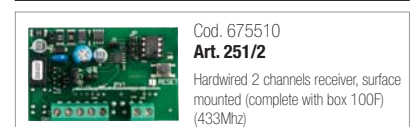

Cod. 675510
Art. 251/2
Hardwired 2 channels receiver, surface mounted (complete with box 100F) (433Mhz)

IRON BOX

Steel vandal-proof box for **REV** and **GULLIVER** with magnetic limit switches and foundation plate

COD.	ART.	DIMENSIONS	Kg
619080	IRONBOX	580 x 280 x 902h	44 Kg

For technical details see on page 38



GULLIVER



DEA AUTOGATE INDONESIA

0878 8399 0876

0896 9998 3721

www.deaautogate.id

move as you like