



NET230N 230V a.c. operators with control board, limit switches and encoder

COD.	Art.	EN 12453 IN COMPLIANCE WITH STANDARDS EN 12445	Max. weight	Encoder	DEA	Encoder	OTHER CHARACTERISTICS
614140	6NET	EN 12453 IN COMPLIANCE WITH STANDARDS EN 12445	600 kg	•	NET230N	•	- Self locking with limit switches - Speed adjustment and slow down in opening and closing - Motor control by encoder and obstacle detection
615180	9NET	EN 12453 IN COMPLIANCE WITH STANDARDS EN 12445	900 kg	•	NET230N	•	

All models have: fixing plate (to be screwed) included

NET24N 24V d.c. operators with control board and limit switches

COD.	Art.	EN 12453 IN COMPLIANCE WITH STANDARDS EN 12445	Max. weight	Encoder	DEA	OTHER CHARACTERISTICS
614121	5/24NET/F	EN 12453 IN COMPLIANCE WITH STANDARDS EN 12445	500 kg	•	NET24N	- Self locking with limit switches - Speed adjustment and slow down in opening and closing - Motor control by encoder and obstacle detection
615161	8/24NET/F	EN 12453 IN COMPLIANCE WITH STANDARDS EN 12445	800 kg	•	NET24N	- Anti-crushing device

All models have: fixing plate (to be screwed) included

212E 230V d.c. operators with control board and limit switches

COD.	Art.	Max. weight	Encoder	DEA	OTHER CHARACTERISTICS
614110*	403E	400 kg	•	212E	- Self locking with limit switches - Electronic force adjustment
615150*	803E	800 kg	•	212E	- Self learning working times - Controlled input for external safety devices

* In order to respect the limit of impact forces foreseen by EN 13241-1, you must use the external safety devices in compliance with EN 12978.

TECHNICAL INFO	403E - 6NET	803E - 9NET	5/24NET/F	8/24NET/F
Motor power supply (V)	230 V ~ ±10% (50/60 Hz)	230 V ~ ±10% (50/60 Hz)	24 DC	24 DC
Maximum power absorption (W)	320	450	80	110
Max thrust (N)	340	490	210	260
Duty cycle (cycles/h)*	18	11	22	18
N. max. cycles in 24 h.*	60	40	60	40
Built-in capacitor (µF)	8	12,5	\	\
Operating temperature (°C)	-20 ÷ 40	-20 ÷ 40	-20 ÷ 40	-20 ÷ 40
Motor thermal protection (°C)	140	160	\	\
Speed (m/min)	10	10	10	10
Weight with packing (Kg)	11	12,5	12	12
Protection degree	IPX4	IPX4	IPX4	IPX4

* For a 5 mt. long leaf

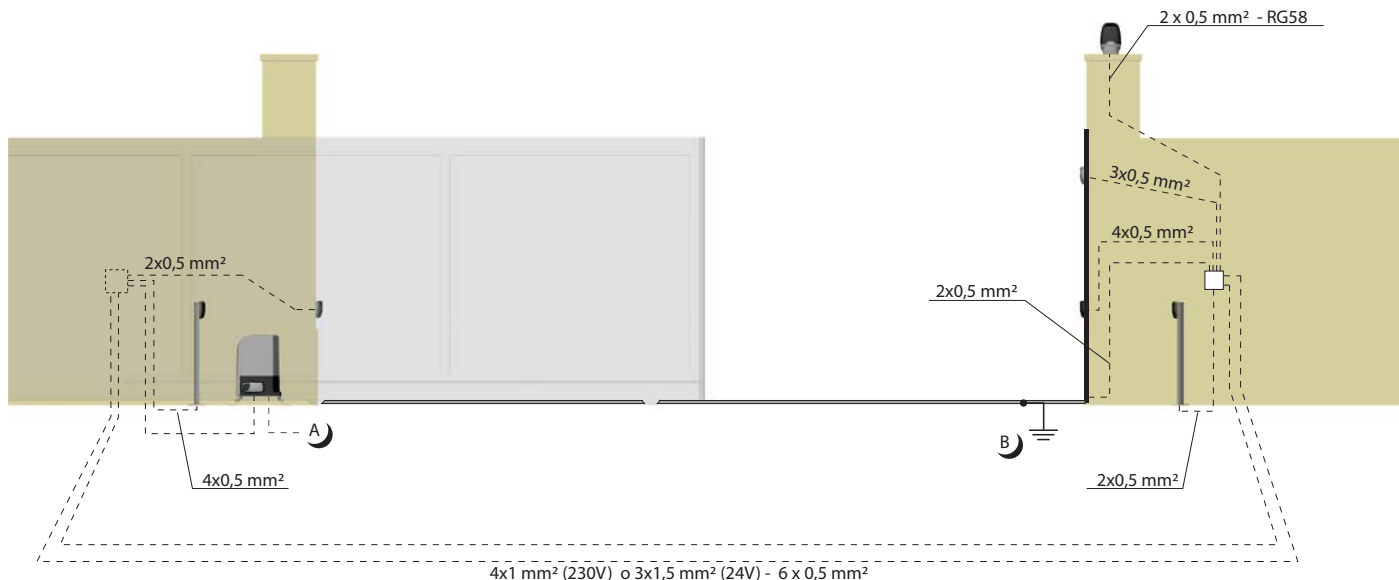



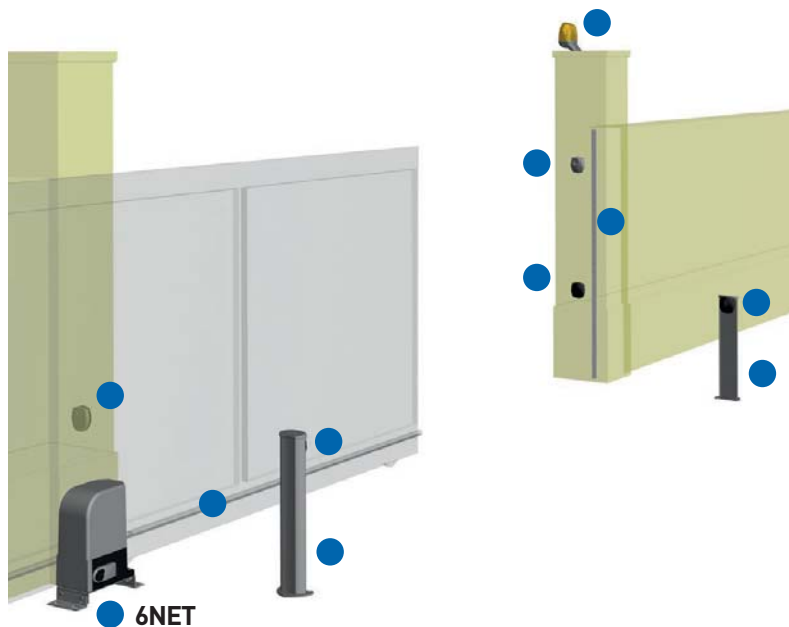



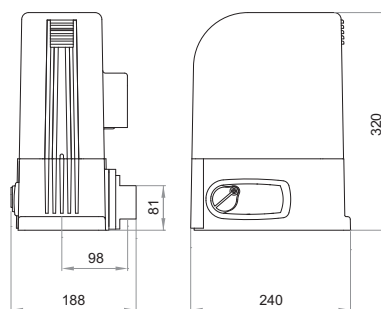

EXAMPLE OF A TYPICAL INSTALLATION



DIMENSIONS



 <p>Cod. 614140 Art. 6NET Automation for residential sliding gates</p>	 <p>Cod. 619010 Art. 460 Foundation plate to be cemented</p>	 <p>Cod. 619000 Art. 111 NYLON rack, with fixing screws (per mt.)</p>
 <p>Cod. 662030 Art. 104LUX Pair of adjustable (15°) surface mounted photocells</p>	 <p>Cod. 664000 Art. PILLY/60 Pair of aluminium columns for photocells, height 55 cm.</p>	 <p>Cod. 171001 Art. 123 Mechanical safety rib, length 200 cm.</p>
 <p>Cod. 663030 Art. 102LUX Keyswitch with two contacts, flush mounted. Supplied with 2 keys.</p>	 <p>Cod. 661062 Art. LED230AI Led flashing light 230V with built-in antenna 433Mhz</p>	 <p>Cod. 672580 Art. TR2 Remote control Black version art. TR2N also available (page 118)</p>
 <p>Cod. 668010 Art. 127 Warning sign</p>		

SPECIFIC ACCESSORIES

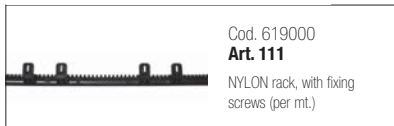

Cod. 619000
Art. 111
NYLON rack, with fixing screws (per mt.)



Cod. 619040
Art. 450
Unlocking device by cable for LIVI.
To be used with BLINDOS



Cod. 675580
Art. RADIOBAND RU
868Mhz receiver



Cod. 171000
Art. 124
Mechanical safety rib, 1,5 mt.

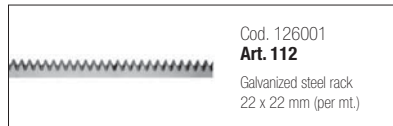

Cod. 126001
Art. 112
Galvanized steel rack 22 x 22 mm (per mt.)



Cod. 619010
Art. 460
Foundation plate to be cemented



Cod. 171001
Art. 123
Mechanical safety rib, 2 mt.

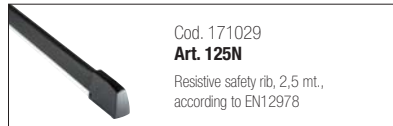

Cod. 171029
Art. 125N
Resistive safety rib, 2,5 mt., according to EN12978



Cod. 126000
Art. 113
Galvanized steel rack 30x12 mm with zinc-plated spacers and fixing screws (per mt.)

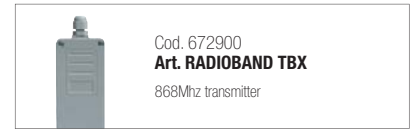

Cod. 672900
Art. RADIOBAND TBX
868Mhz transmitter

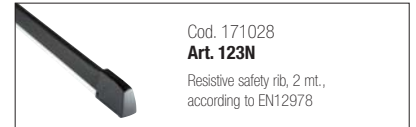

Cod. 171028
Art. 123N
Resistive safety rib, 2 mt., according to EN12978



Cod. 667053
Art. Soft3
Safety rubber profile (complete with aluminium base) useful to reduce the impact forces for sliding and swing gates. 12mt.

OTHER ACCESSORIES

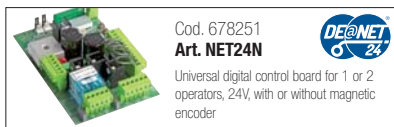

Cod. 678251
Art. NET24N
Universal digital control board for 1 or 2 operators, 24V, with or without magnetic encoder

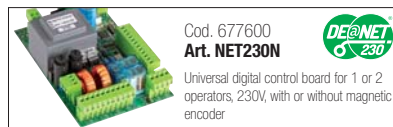

Cod. 677600
Art. NET230N
Universal digital control board for 1 or 2 operators, 230V, with or without magnetic encoder

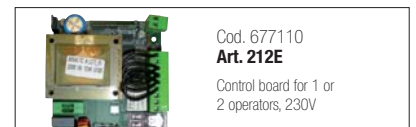

Cod. 677110
Art. 212E
Control board for 1 or 2 operators, 230V



Cod. 661082
Art. LED24AI
Led flashing light 24V with built-in antenna 433Mhz



Cod. 661062
Art. LED230AI
Led flashing light 230V with built-in antenna 433Mhz



Cod. 672580
Art. TR2
Remote control
Black version art. TR2N also available (page 118)



Cod. 672590
Art. TR4
Remote control
Black version art. TR4N also available (page 118)



Cod. 662020
Art. 104MINILUX
Pair of surface mounted photocells. Range 20 mt



Cod. 662030
Art. 104LUX
Pair of adjustable (15°) surface mounted photocells



Cod. 662044
Art. LINEAR
Pair of adjustable photocells (180°) with possibility of synchronized operating. Range 20 Mt



Cod. 662043
Art. LINEAR/B
Pair of adjustable photocells (180°) with tx supplied by a LiON battery. Range 7/15 Mt



Cod. 681060
Art. COVER
Vandal-proof aluminium cover for art. LINEAR and LINEAR/B



Cod. 663060
Art. KYO
Aluminium vandal-proof keyswitch, flush mounted.



Cod. 663280
Art. DIGIRAD
Wireless keypad



Cod. 663270
Art. DIGINET
Hardwired keypad for BUS connections to MASTER devices of range DE@NET (NET24N, NET230N, MASTERNET)



Cod. 664020
Art. PILLY/base
Pair of fixing plates for columns to be cemented.



Cod. 664000
Art. PILLY/60
Pair of aluminium columns for photocells, height 55 cm.



Cod. 664010
Art. PILLY/120
Pair of aluminium columns for photocells, height 100 cm.

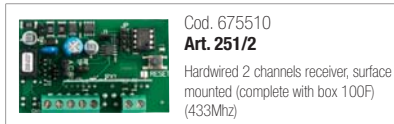

Cod. 675510
Art. 251/2
Hardwired 2 channels receiver, surface mounted (complete with box 100F) (433Mhz)



Cod. 629290
Art. BAT
Rechargeable batteries kit for 24V operators, 12V - 1,3Ah, complete with wiring cables



Cod. 681050
Art. Green Energy
Solar power kit complete with art. CHARGER



Cod. 665000
Art. BLINDOS
Safety enclosure to place external unlocking device handle

DEA[®]
move as you like

DEA AUTOGATE INDONESIA

0878 8399 0876
0896 9998 3721

www.deaautogate.id

LIVI

